

## FY-GL-CS II-A684W



[More details about this cob led grow light](#)



## FEATURES

- High efficacy up to 2.3  $\mu\text{mol}/\text{J}$ .
- IP54 dustproof.
- Top-bin CREE or Citizen COB LEDs.
- 100-277 V wide input voltage.
- Light uniformity distribution.
- 3 Channels to dimmable control of VEG, bloom and COB separately.
- Full spectrum 12 bands for VEG to bloom, full growing stages.
- Light uniformity distribution.

## CERTIFICATES

EMC / LVD / RoHS

## WARRANTY

Default is 3 years. 5 years warranty is optional

## APPLICATIONS

- Home hobbyist
- Agricultural universities
- Educational programs in local school districts
- Plant physiological research
- Biotechnology
- Pharmacology
- Greenhouses
- Plant factories

## SPECIFICATION

Model	FY-GL-CS II- A684W
Spectrum	Full Spectrum
Input Voltage	AC 100-277 V, 50 / 60 HZ
Power Factor	>0.95
Dimming	0-10 V
Dimension	22" x 19.2" x 2.7" L 560 * W 490 * H 70mm
LED Quantity	3 * 100 W+128 * 3 W
Rated Power	684 W
Draw Power	500 W
PPF	1150 $\mu\text{mol}/\text{s}$

Efficacy	2.3 $\mu\text{mol}/\text{J}$
IP Rating	IP54
Beam Angle	90°
Operating Temperature	-4 - 104 °F / (-20 - 40 °C)
Lifetime	Q (L)90: 68, 300 hours
Certificates	CE, RoHS
Warranty	5 years
Master carton (1PC/ CTN)	610 * 545 * 130 mm
Gross Weight	10.2KG/PC
Volume weight	8.8KG/PC

## SPECTRUM

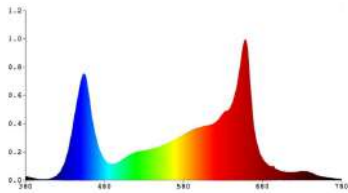

3 Channels control separately  
All LED Channels on

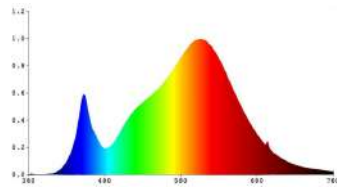

CH1-ALL COBs are working

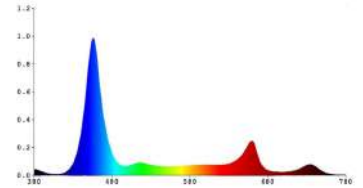

CH2-VEG Stage

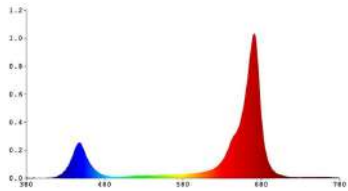

CH3-Flowering Stage

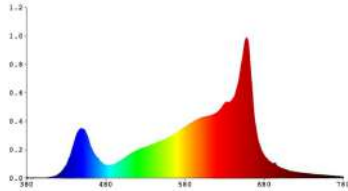

CH4-CH1+CH3

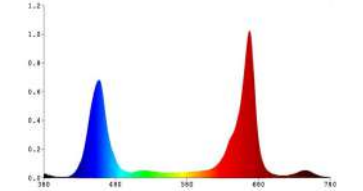

CH5-CH2+CH3

## ACCESSORIES



6FT POWER CABLE -1PC



ADJUSTABLE STAINLESS STEEL  
HANGING KITS -1SET

## DIMENSIONS

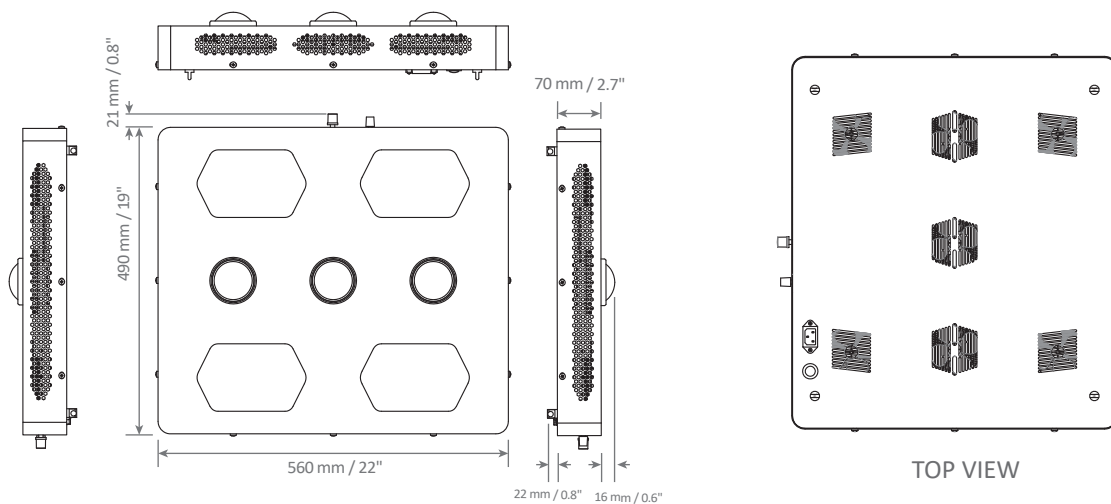

## PACKING INFORMATION

G.W.of inner carton	Size of inner box	Size of master carton	Quantity of master carton	G.W.of master carton	Storage temperature
BLANK	BLANK	610 * 545* 130 mm	1pc	10.2KG/PC	-40°C~80°C