

FY-GL-CS II-A292W

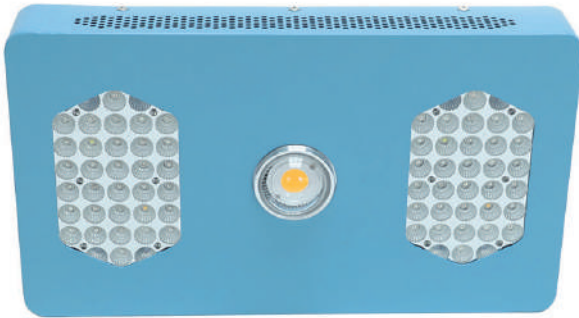

[More details about this cob led grow light](#)



SPECIFICATION

Model	FY-GL-CS II- A292W
Spectrum	Full Spectrum
Input Voltage	AC 100-277 V, 50 / 60 HZ
Power Factor	>0.95
Dimming	0-10 V
Dimension	19.2" x 11" x 2.7" L 490 * W 280 * H 70 mm
LED Quantity	1 * 100 W + 64 * 3 W
Rated Power	292 W
Draw Power	200 W
PPF	460 μmol/s

FEATURES

- High efficacy up to 2.3 μmol/J.
- IP54 dustproof.
- Top-bin CREE or Citizen COB LEDs.
- 100-277 V wide input voltage.
- Light uniformity distribution.
- 3 Channels to dimmable control of VEG, bloom and COB separately.
- Full spectrum 12 bands for VEG to bloom, full growing stages.
- Light uniformity distribution.

CERTIFICATES

EMC / LVD / RoHS

WARRANTY

Default is 3 years. 5 years warranty is optional

APPLICATIONS

- Home hobbyist
- Agricultural universities
- Educational programs in local school districts
- Plant physiological research
- Biotechnology
- Pharmacology
- Greenhouses
- Plant factories

Efficacy	2.3μmol/J
IP Rating	IP54
Beam Angle	90°
Operating Temperature	-4 - 104 °F / (-20 - 40 °C)
Lifetime	Q (L)90: 68, 300 hours
Certificates	CE, RoHS
Warranty	5 years
Master carton (1PC / CTN)	535 * 445 * 110 mm
Gross Weight	5.6KG/PC
Volume weight	5.2KG/PC

SPECTRUM

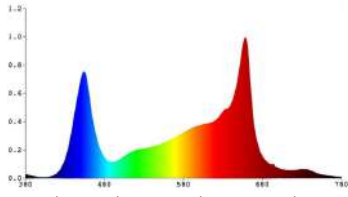

3 Channels control separately
All LED Channels on

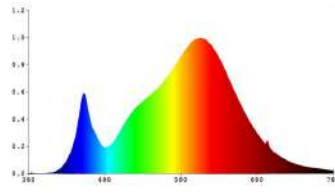

CH1-ALL COBs are working

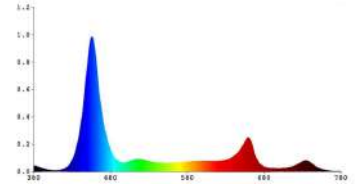

CH2-VEG Stage

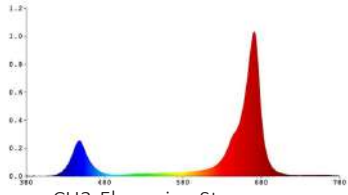

CH3-Flowering Stage

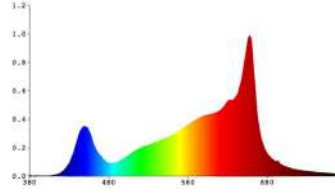

CH4-CH1+CH3

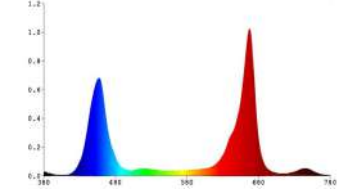

CH5-CH2+CH3

ACCESSORIES



6FT POWER CABLE -1PC



ADJUSTABLE STAINLESS STEEL
HANGING KITS -1SET

DIMENSIONS

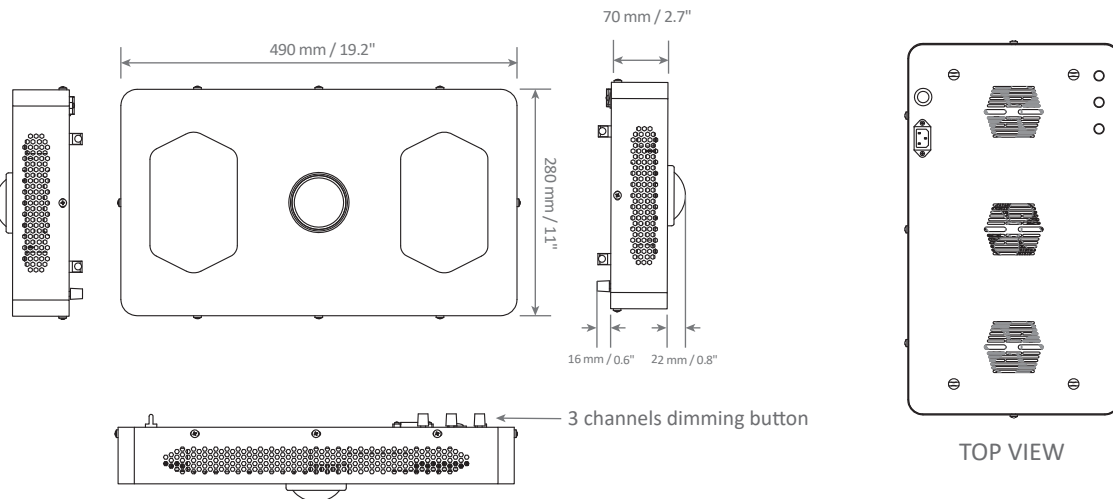

PACKING INFORMATION

G.W.of inner carton	Size of inner box	Size of master carton	Quantity of master carton	G.W.of master carton	Storage temperature
BLANK	BLANK	535 * 445 * 562 mm	1pc	5.6KG/PC	-40°C~80°C